

Welcome Back!



YISHUN SECONDARY SCHOOL
We Seek We Strive We Soar



Dear students,

You have worked hard to reach this stage. Let's celebrate your efforts!



Finally, we are going to get our results!



YISHUN SECONDARY SCHOOL
We Seek We Strive We Soar

Thinking about Your Next Step?

Consider these questions!

Where do I want to go?

Who am I?



How Do
I Get There?



Admission Exercises

Things to note





Where am I now?

What can I apply for?

Where do I want to go?

N(T)-Level Student

ITE EAE

JIE 'N'/JIE 'E'

Institute of Technical Education (ITE) (Enhanced Foundation Programme, 2-year Nitec or 3-year Higher Nitec)

N(A)-Level Student

Eligible students may also progress to Secondary 5 to take the O-Level examinations. Applications can be made via your secondary school.

PFP

ITE EAE

JIE 'N'

DPP

NFP

Polytechnic

Institute of Technical Education (ITE) (2-year Nitec or 3-year Higher Nitec)

Institute of Technical Education (ITE) (2-year Higher Nitec)

Nanyang Academy of Fine Arts (NAFA)

EAE: Early Admissions Exercise
JIE: Joint Intake Exercise
PFP: Polytechnic Foundation Programme

DPP: Direct-Entry-Scheme to Polytechnic Programme
NFP: NAFA Foundation Programme



<https://www.moe.gov.sg/post-secondary/admissions>

For more information on applying to these courses, you can visit

<https://ite.edu.sg/admissions/traineeship>

For the list of 3-year Higher Nitec courses, please visit <https://www.ite.edu.sg/courses/full-time-courses/nitec-and-3-year-higher-nitec>







Selected Nitec and Higher Nitec courses are available in traineeship mode.





YISHUN SECONDARY SCHOOL

We Seek We Strive We Soar

Admissions Exercises Application Timeline

Admissions Exercises	JIE 'N'			PFP	
	JIE 'E'			DPP	
	NFP				
	DPP				
	(1 st window of applications)			(2 nd window of applications)	
Application Period	Dec 2024			Jan 2025	

 N(T)-Level Student

 N(A)-Level Student



Details of Admission Exercises





JIE 'N'/JIE 'E' – Joint Intake Exercise

The JIE 'N' is for 2-year *Nitec* or 3-year *Higher Nitec* courses offered by ITE.

The JIE 'E' is for GCE N(T) students to apply for the 3-year *Nitec* course with Enhanced *Nitec* Foundation Programme.



go.gov.sg/applyjie

-  N(T)–Level Student
-  N(A)–Level Student



Details of Admission Exercises



PFP – Polytechnic Foundation Programme

PFP is a one-year programme that offers a practice-oriented curriculum taught by polytechnic lecturers to better prepare polytechnic-bound Secondary 4 N(A) students for entry into selected polytechnic diploma courses. PFP students are given provisional places in diploma programmes, subject to them passing all modules in the one-year programme.



go.gov.sg/pfp



DPP – Direct-Entry-Scheme to Polytechnic Programme

DPP allows Secondary 4N(A) students to be admitted directly into selected 2-year *Higher Nitec* programmes at ITE without having to sit for the O-Level examinations or undergo a *Nitec* programme. DPP students who successfully complete their *Higher Nitec* courses at ITE and attain the required qualifying Grade Point Average (GPA) scores are guaranteed a place in a polytechnic diploma course mapped to their *Higher Nitec* course.



go.gov.sg/applydpp





NFP – NAFA Foundation Programme

NFP is a one-year practice-based programme that prepares N(A)-Level holders to pursue a diploma in the creative arts. NFP students who successfully complete the programme will be offered a place in their chosen diploma course at NAFA.



go.gov.sg/nafa-applynow



 N(T)-Level Student
 N(A)-Level Student



YISHUN SECONDARY SCHOOL

We Seek We Strive We Soar

Key Dates for Jan 2025 Intake Exercise

Key Activity	Period for 2-Year and 3-Year Nitec Courses, and 3-Year and 4-year Higher Nitec courses	Remarks
1st Phase (Main Phase)		
Application	16 Dec 2024 (2.30pm) to 19 Dec 2024 (5pm)	Apply through the Internet at https://www.ite.edu.sg with NRIC / FIN and Date of Birth. You may also apply using SingPass.
Release of Results	30 Dec 2024 at 9am	Check results at https://istudent.ite.edu.sg with web ID and password
Acceptance of Course Offer Period	30 Dec 2024 to 3 Jan 2025	Accept course offer at https://istudent.ite.edu.sg with web ID and password
2nd Phase (Late Application/Appeal Phase)		
Application	30 Dec 2024 to 3 Jan 2025	Apply through the Internet at https://istudent.ite.edu.sg with NRIC / FIN and Date of Birth. You may also apply using SingPass.
Release of Results	10 Jan 2025 at 9am	Check results at https://istudent.ite.edu.sg with web ID and password
Acceptance of Course Offer Period	10 Jan 2025 to 12 Jan 2025	Accept course offer at https://istudent.ite.edu.sg with web ID and password
3rd Phase (Final Top-up Phase)		
Application	1 st Top-up Phase Application - 10 Jan to 17 Jan 2025 2 nd Top-up Phase Application - 23 Jan to 7 Feb 2025	Apply through the Internet at https://istudent.ite.edu.sg with NRIC / FIN and Date of Birth. You may also apply using SingPass.
Release of Results	1 st Top-up Phase - 14 Jan to 23 Jan 2025 2 nd Top-up Phase - 23 Jan to 13 Feb 2025	Check results at https://istudent.ite.edu.sg with web ID and password
Acceptance of Course Offer Period	1 st Top-up Phase - 14 Jan to 23 Jan 2025 2 nd Top-up Phase - 23 Jan to 13 Feb 2025	Accept course offer at https://istudent.ite.edu.sg with web ID and password

Jan 2025 Intake Term Commencement Date: **13 Jan 2025**

Information For Students on Key Dates for Jan 2025 intake

1. All N(A)*/N(T) school leavers are encouraged to submit an application during the **1st Phase (Main Phase)** between **16 Dec 2024 (2.30pm) to 19 Dec 2024 (5pm)**. Application results for the 1st Phase will be released on **30 Dec 2024 at 9am**.
2. If you wish to appeal, please accept the course offered **before** applying in the **2nd Phase (Late Application/Appeal Phase)** between **30 Dec 2024 to 3 Jan 2025**. The application results for the 2nd Phase will be known on **10 Jan 2025 at 9am**.
3. Unsuccessful applicants can appeal under the **3rd Phase (Final Top-up Phase)** between **10 Jan to 17 Jan 2025 and 23 Jan to 7 Feb 2025** for courses with vacancies. The application results for the 3rd Phase will be known between **14 Jan to 23 Jan 2025** and **23 Jan to 13 Feb 2025**.

*N(A) students progressing to ITE

For further enquiries, N-Level school leavers can contact
ITE Hotline: 1800-2222-111



Progression for 4 Normal Technical

Where am I now?

N(T)-Level Student

What can I apply for?

ITE EAE

JIE 'N'/JIE 'E'

Where do I want to go?

Institute of Technical Education (ITE) (Enhanced Foundation Programme, 2-year Nitec or 3-year Higher Nitec)



Progression for 4 Normal Technical

Option1: Laterally Transfer to Sec 4 Normal Academic

Criteria:

- Grade A for both EL & Math and
- Grade B or better in one other subject

Option 2: Institution of Technical Education (ITE)

a) Joint Intake Exercise [JIE 'N']

- 2-year Nitec or 3-year Higher Nitec courses offered by ITE

b) Joint Intake Exercise [JIE 'E']

- Sec 4N(T) students with 0 or 1 N(T)-Level subject pass can enrol in the enhanced Nitec Foundation Programme (**e-NFP**) or the enhanced Foundation Programme (**eFP**)



Online Application for

2-Year Nitec and 3-Year Higher Nitec Courses

3-Year Nitec/4-year Higher Nitec Course with EFP

(for N(T) students with 0, 1 "N" pass)

1. Go to <https://www.ite.edu.sg>.

2. Click  icon.

3. Under JIE 'N', click  icon to link to the application website

Under JIE 'E', click  icon to link to the application website

4. At the application website:

- a) Enter NRIC / FIN and Date of Birth to start application. You may also apply using SingPass.
- b) Upon completion of application, applicants will receive their **web ID** and password.

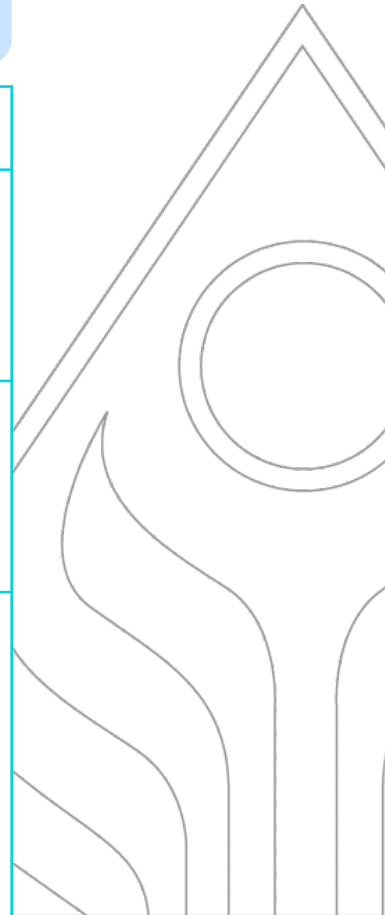

Checking of Posting Results/Accept Course Offer

2-Year Nitec and 3-Year Higher
Nitec Courses

3-Year Nitec/4-year Higher Nitec
Course with EFP
(for N(T) students with 0, 1 "N" pass)

1. Go to <https://istudent.ite.edu.sg>.
2. Enter **web ID** and password.
3. Click '**Self-Service**' followed by '**Student Admission**' followed by '**View Application Results**' to view the application results and to accept course offer.

The above steps applies to all phases (refer to [Slide 11](#) for dates).
For more details, please refer to ITE website.



Additional Information For Students

Should you require further advice or assistance in your applications or future plans, please contact your teachers and/or ECG Counsellor.

For further inquiries, you may refer to the following hotlines and links for more information and advice on further education:

Institute of Technical Education (ITE)	
ITE Hotline (for ITE admissions and courses)	1800 2222 111 training@ite.edu.sg
ECG Centre @ MOE	
e-Appointment link	https://go.gov.sg/moe-ecg-centre



Additional Information For Students

The information listed in the table below will help you to make an informed decision on which choice of courses you could consider applying at ITE.

S/N	Information	Attachment/Link
1	ITE Factsheet 2024	 2024 JIEN Factsheet
2	ITE Course Booklet 2025	https://www.ite.edu.sg/courses/full-time-courses/download-ite-course-booklet
3	Information on Progression Opportunities (From <i>Nitec</i> Courses to <i>Higher Nitec</i> and Technical diplomas)	https://www.ite.edu.sg/admissions/full-time-courses/nitec-and-3-year-higher-nitec/progression-opportunities
4	Information on Progression Opportunities (from <i>Higher Nitec</i> courses to diploma courses)	https://www.ite.edu.sg/admissions/full-time-courses/higher-nitec/academic-progression



Progression Pathways for 4 Normal Academic

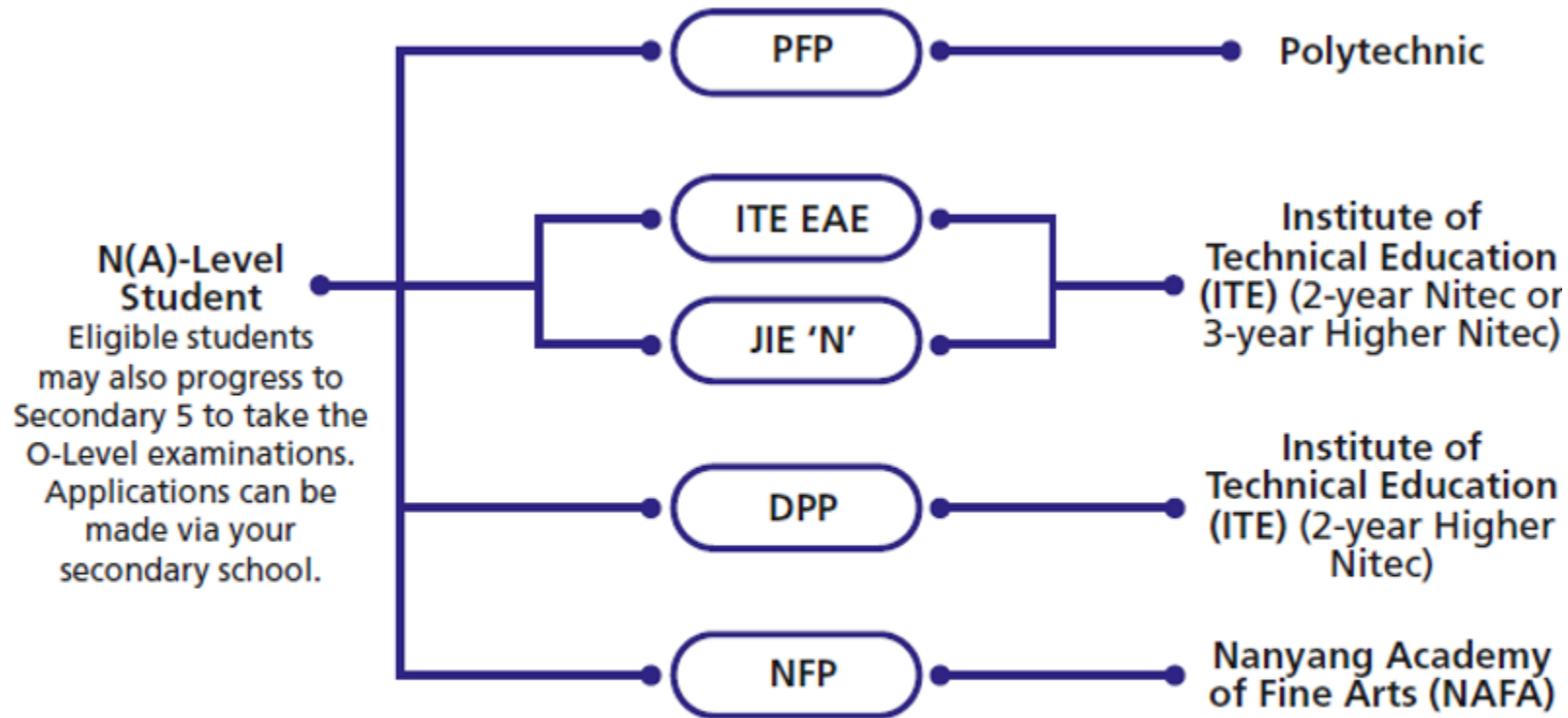

EAE: Early Admissions Exercise
JIE: Joint Intake Exercise
PFP: Polytechnic Foundation Programme

DPP: Direct-Entry-Scheme to Polytechnic Programme
NFP: NAFA Foundation Programme



Progression Pathways for 4 Normal Academic

Option 1: Promotion to Sec 5 NA

Criteria:

- *Obtained an ELMAB3 aggregate score of 19 points or less (excluding bonus points), **and***
- At least an N(A)-level Grade 5 for all subjects used in the computation of ELMAB3

How to apply?

- Application form can be obtained from Form Teacher.
- Submit application forms to the general office by **Thursday, 19 December 4pm**

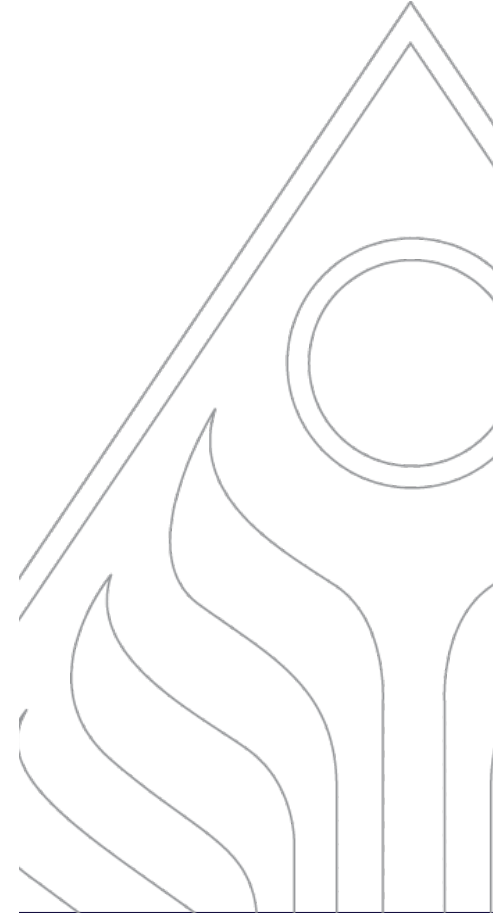

Progression Pathways for 4 Normal Academic

Option 2: Progression to Polytechnic Foundation Programme (PFP)

What is PFP?

- PFP is a diploma-specific foundation programme conducted over one year.
- Students who pass all modules in the one-year PFP will progress to the first year of the relevant diploma course in the same polytechnic.

Criteria:

- ELMAB3 aggregate score 12 points or less (*excluding CCA bonus points*)
and
- $EL, MA \leq 3$
- Met subject-specific entry requirements stated in
https://pfp.polytechnic.edu.sg/PFP/pfp_eligibility.html



Progression Pathways for 4 Normal Academic

Option 2: Progression to Polytechnic Foundation Programme (PFP)

How to apply:

- Following the release of the GCE O-Level results in January 2025, eligible students may apply for the PFP online via the PFP portal at https://pfp.polytechnic.edu.sg/PFP/pfp_application.html
- More information can be found at <https://pfp.polytechnic.edu.sg/PFP/index.html>

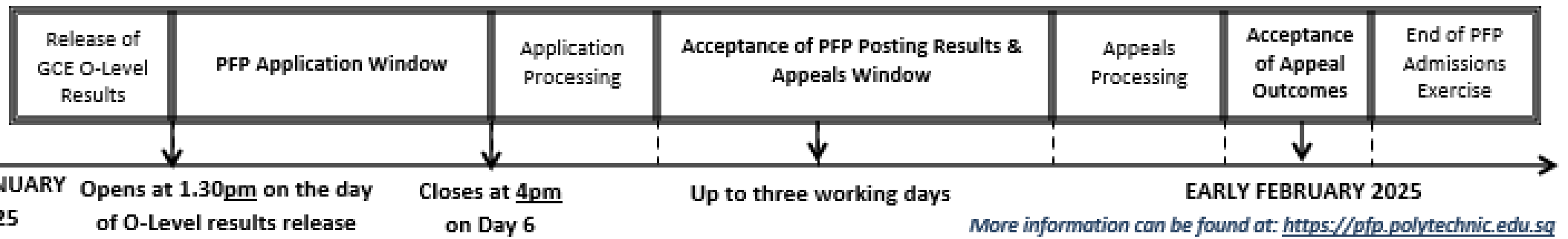

Progression Pathways for 4 Normal Academic

Option 2: Progression to Polytechnic Foundation Programme (PFP)

Points to note for application of PFP:

- Students who are only interested in applying for the PFP should first progress to Sec 5N(A), even if they meet the PFP eligibility criteria based on their GCE N(A)-Level results in December 2024.
- They may then apply for the PFP upon release of the GCE O-Level results in January 2025.
- If their application is successful, they will withdraw from Sec 5N(A) by the end of January 2025.
- All PFP-bound students are required to attend Sec 5N(A) classes in their secondary schools up till 31 January 2025.



Progression Pathways for 4 Normal Academic

Option 3: Institution of Technical Education (ITE) under Direct-Entry Scheme to Polytechnic Programme (DPP)

What is DPP?

- Consist of a two-year Higher Nitec courses at ITE.
- DPP students who successfully complete their Higher Nitec courses and attain the minimum qualifying GPA are subsequently guaranteed a place in a polytechnic diploma course mapped to their Higher Nitec course.
- Successful applicants will be required to attend a 10-week preparatory course prior to commencing their Higher Nitec courses



Progression Pathways for 4 Normal Academic

Option 3: Institution of Technical Education (ITE) under Direct-Entry Scheme to Polytechnic Programme (DPP)

Criteria:

- ELMAB3 aggregate score of 19 points or less (excluding CCA bonus points)
- and**
- Met subject-specific entry requirements for each course, as stated in <https://www.ite.edu.sg/admissions/full-time-courses/higher-nitec-dpp>



Progression Pathways for 4 Normal Academic

Option 3: Institution of Technical Education (ITE) under Direct-Entry Scheme to Polytechnic Programme (DPP)

How to apply:

- Following the release of the GCE N(A)-Level results in December 2024, eligible students may apply for the DPP online via the ITE website (<https://www.ite.edu.sg/admissions/full-time-courses/higher-nitec-dpp>)
- Application opens from **Mon 16 Dec 2024 (2.30pm)** to **Thu 19 Dec 2024 (5pm)**

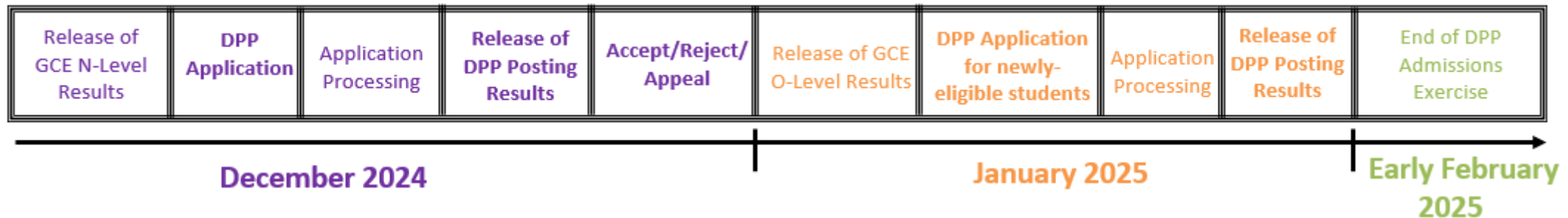

Progression Pathways for 4 Normal Academic

Students who are interested in applying for both the PFP and DPP:

- Students are encouraged to carefully consider their interests and strengths, as well as the courses offered under both programmes.
- One option for students who are interested in both the PFP and DPP is to first progress to Sec 5N(A) and then apply for both the PFP and DPP upon release of the GCE O-Level examination results in January 2025.

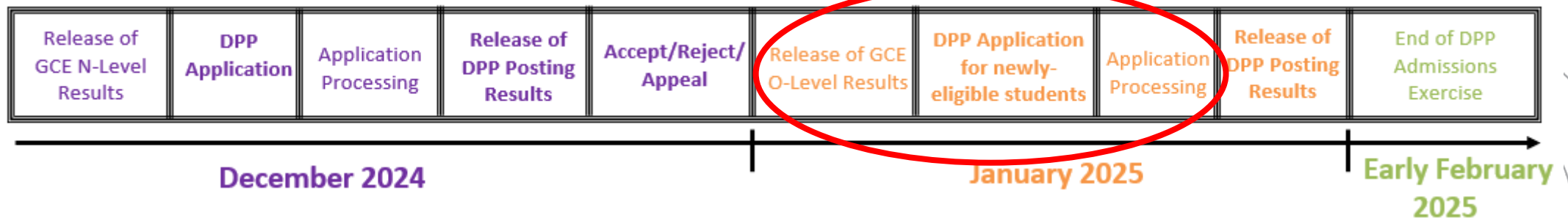

Progression Pathways for 4 Normal Academic

Students who are interested in applying for both the PFP and DPP:

- Students who are offered a place in both the PFP and DPP may only accept one course offer. Students who accept both offers will have both offers voided.
- If their application to either the PFP or DPP is successful, they will withdraw from Sec 5N(A) by the end of January 2025.

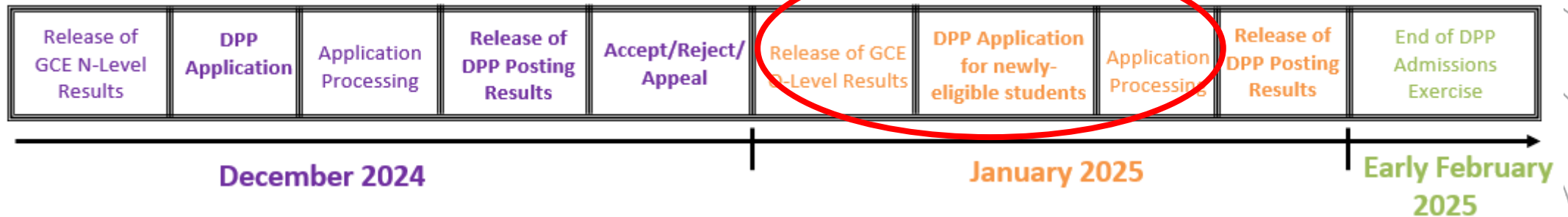

Progression Pathways for 4 Normal Academic

Students who are interested in applying for both the PFP and DPP:

- For students who have already applied for and accepted their DPP offer prior to the release of the GCE O-Level examination results, their secondary school will contact them to collect the PFP eligibility form (Form P) if they are eligible for PFP after the release of the GCE O-Level results.
- Students who decide to apply for and accept their PFP offer in January 2024 will need to withdraw from the DPP course.
- Applicants can apply for a refund of their DPP enrolment fees, subject to ITE's approval.



Post-Secondary Pathways

PFP	Polytechnic Foundation Programme ELMAB3 ≤ 12	<p>For N(A) Students ONLY</p> <p>Aggregate Computation: ELMAB3 [EL + MA + Best 3 other subjects]</p> <p><i>N(A) Grade 6 cannot be used for ELMAB3 computation.</i></p>
NFP	NAFA Foundation Programme ELMAB3 ≤ 15	
Sec 5	Progression to O-Level via Sec 5 ELMAB3 ≤ 19*	
DPP JIE'H ,	Direct-Entry-Scheme to Polytechnic Programme (2-yr Higher Nitec → Mapped to Poly course) ELMAB3 ≤ 19	
JIE 'N'	ITE 3-yr Higher Nitec / 2-yr Nitec Best 4 subjects (check subject requirements)	<p>For Both N(A) & N(T) Students</p>
Train-eeship	ITE Traineeship Scheme	



Form N

to be released during
N-level result release days

Only shows Eligible courses. To decide on one's chance of getting into a course, students may refer to prior year cut-off points and compute their ITE aggregate points AND ELMAB3 based on the courses they apply.

JIE E: 3YR NITEC
If you have received an additional letter, then you are eligible for the Enhanced Foundation Programme (EFP).



2016 JOINT INTAKE EXERCISE (GCE 'N' LEVEL) FOR ITE COURSES FORM N

* Based on your 2015 GCE 'N' Level Examination results, you are eligible to apply for the ITE Full-time and Traineeship courses listed below.

Joint Intake Exercise 'H' Full-time Higher Nitec Courses under Direct-Entry-Scheme to Polytechnic Programme (DPP)

Course	College	Course	College	Course	College
FPBIS	CE-SM	FPINT	CC-AM	FPNST	CW-CK
FPCHT	CE-SM	FPINT	CE-SM		
FPCSE	CC-AM	FPINT	CW-CK		
FPECE	CC-AM	FPMCE	CC-AM		
FPECE	CE-SM	FPMCE	CW-CK		
FPECE	CW-CK	FPMCE	CC-AM		
FPELE	CE-SM	FPMCE	CE-SM		
FPELE	CW-CK	FPMCE	CW-CK		
FPGAD	CC-AM	FPNST	CE-SM		

Joint Intake Exercise 'N' Full-time 2-Year Nitec Courses

Course	College	Course	College	Course	College	Course	College	Course	College
NFAAZ*	CC-AM	NFECB	CE-SM	NFFSZ	CE-SM	NFICN	CE-SM	NPRTZ	CW-CK
NFACZ*	CW-CK	NFECB	CE-SM	NFFSZ	CW-CK	NFICN	CW-CK	NPSDA*	CC-AM
NFAFZ	CE-SM	NFECI	CC-AM	NFFTA	CE-SM	NFLSZ	CE-SM	NPSDI*	CC-AM
NFAMZ	CC-AM	NFECM	CE-SM	NFFTA	CW-CK	NFLTZ	CC-AM	NPSTZ	CW-CK
NFATH	CW-CK	NFECN	CC-AM	NFFTL	CE-SM				
NFATL	CW-CK	NFECN	CE-SM	NFFTM	CE-SM				
NFATZ*	CC-AM	NFECN	CW-CK	NFFTM	CW-CK				
NFBSZ	CC-AM	NFECU	CC-AM	NFFTV	CE-SM				
NFBSZ	CE-SM	NFELL	CE-SM	NFFTZ*	CC-AM				
NFBSZ	CW-CK	NFELL	CW-CK	NFFTZ*	CE-SM				
NFBWZ*	CE-SM	NFELP	CE-SM	NFFTZ*	CW-CK				
NFCPZ	CE-SM	NFELP	CW-CK	NFHFD*	CE-SM				
NFCBZ*	CE-SM	NFFAZ*	CC-AM	NFICC	CE-SM				
NFDAN*	CC-AM	NFFBZ	CW-CK	NFICC	CW-CK				
NFDVZ	CE-SM	NFFLE	CC-AM	NFICM	CW-CK				
NFDVZ	CW-CK	NFFSZ	CC-AM	NFICN	CC-AM				

*Applicants who have applied and are shortlisted for these courses will be required to attend an admission interview and/or test on 23 Dec 15 or 24 Dec 15 or 26 Dec 15.

You may refer to the ITE's Admission Booklet for the names of courses and ITE colleges. To apply, please go to www.ite.edu.sg and click on the hotspot to link you to the application website. At the application website, key in your NRIC/FIN and Birthdate to start your application. Applicants are allowed to indicate a maximum of 12 choices. There is no guarantee that applicants will automatically be granted a place in one of the courses applied for. Admission to a course is based on merit and vacancies for the course.

Traineeship Intake

Course	Course	Course	Course	Course	Course	Course
NAACZ	NABSZ	NAPTM	NAMCZ	NAWCZ	T2GST	T2PET
NAATH	NABWZ	NAHSD	NAPBZ	T2ACM	T2MEL	T2PIF
NAATL	NAPBZ	NAICN	NARSZ	T2DET	T2MRM	T2STF

You can also choose to enrol in a Traineeship course which will earn an income, and be awarded with the ITE Course Certificate and Traineeship Certificate. To apply, please go to www.ite.edu.sg and click on the hotspot to link you to the application website.

ITE BOOK THE UNIT THE UNIT

**JIE H:
DPP (2 YR H.NITEC)**

**JIE N:
2 YR NITEC &
3 YR H.NITEC**

Traineeship

ADMISSION & COURSE INFORMATION BROCHURE FOR JANUARY 2025 JOINT INTAKE EXERCISE (JIE) FOR FULL-TIME COURSES



NOTE TO GCE 'N' LEVEL HOLDERS

Congratulations to all GCE 'N' Level holders for completing your secondary school education! You will receive a Form N, showing the list of full-time

Apply
To apply
informa
JIE, p
Contact



ore
TE
QR

Calculating EMB3 for PFP & DPP

NA Grade	Aggregate Point for PFP & DPP
1	1
2	2
3	3
4	4
5	5

O Level Grade	Aggregate Point for PFP & DPP
A1 – B3	1
B4 – C6	2
D7	3
E8	4

Note: **Grade '9'** in the GCE 'O'-Level **does not count** for the computation of the **ELMAB3** aggregate score.

Type of Bonus Points	Bonus Points Awarded
<p><u>CCA Bonus</u> For students with the CCA grades:</p> <ul style="list-style-type: none"> a) Excellent or Grades of A1 – A2 b) Good or Grades of B3 – C6 	<p>2 points 1 point</p>

Calculating Aggregate for 3-Yr Higher Nitec & 2-Yr Nitec Courses

NT Grade	ITE Aggregate Point
A	1
B	2
C	3
D	4
E / U	5

NA Grade	ITE Aggregate Point
1, 2, 3	1
4	2
5	3
6/U	4

O Level Grade	ITE Aggregate Point
A1 – D7	1
E8	2
F9	3

Type of Bonus Points	Bonus Points Awarded
<p><u>CCA Bonus</u> For students with the CCA grades: a) Excellent or Grades of A1 – A2 b) Good or Grades of B3 – C6</p>	<p>2 points 1 point</p>

Note: The Normal (Technical) Grade E/U, Normal (Academic) Grade 6/U and GCE 'O' Level Grade F9 will not be allowed to be used for fulfilment of subject-specific minimum entry requirements. However, these grades will be allowed to be used for aggregate computation for admission to full-time 3-year Higher Nitec and 2-year Nitec courses.

Key Points to Note for 3-Yr Higher Nitec Courses

- **42** 3-Yr Higher Nitec Courses

- Students do well in Semester 1 of Year 1 may be identified for an **accelerated pathway** to complete the Higher Nitec course in less than 3 years
- Higher Nitec students who meet a Grade Point Average (GPA) of 3.5 will be **guaranteed admission to a polytechnic course** mapped to their Higher Nitec course from AY2027.
- Multiple Progression Opportunities after ITE

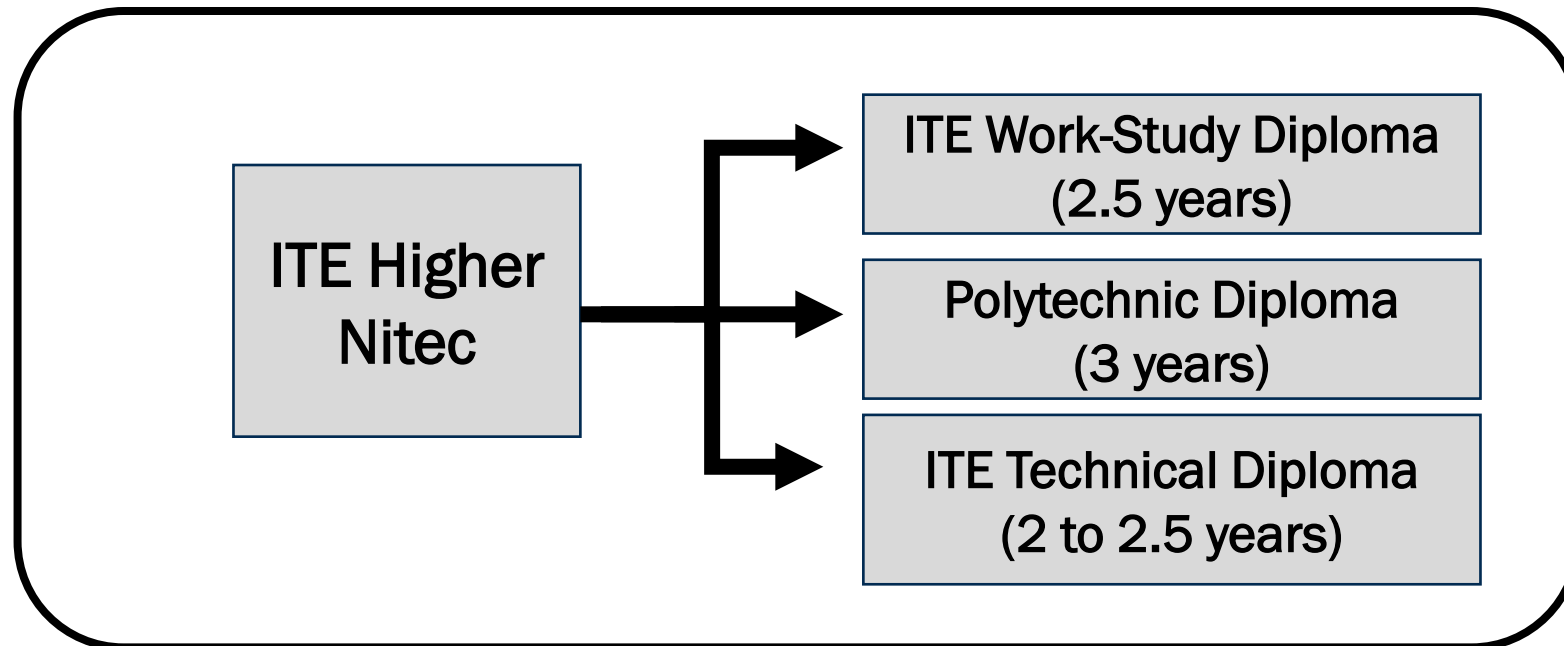

Key Pointers for Students on ITE's Joint Intake Exercise (JIE)

ALL students in N(T) and N(A) students (who are not progressing to 5N(A) or repeating 4N(A)) are eligible for JIE.
Those who were unsuccessful in EAE are also eligible for JIE.

Participation in JIE Main Phase is key to securing a place in ITE!

Use all 12 JIE choices wisely, as competition for 3-year Higher Nitec courses is keen!

Do consult your teachers / ECG counsellors to help you make your choices!

Do use the Last Aggregate Score (LAS) published in ITE's admission portal to help you make your course choices.

If you have received an additional letter, then you are eligible for the Enhanced Foundation Programme (EFP).

If you are eligible for EFP, make sure you apply for both the EFP and the 2-year Nitec/3-year Higher Nitec!

The EFP helps to build the necessary literacy and numeracy foundations that will enable you to successfully complete your course!

If you are counter-offered a course, accept it first before appealing for another course you may be more interested in!



Education and Career Guidance (ECG) Support for 'N' Level Students

Our in-house ECG Counsellor, Ms Teoh, will be in YSS on:

- 16 Dec 2024 (Mon), 2pm to 5pm (Hall)
- 17 Dec 2024 (Tue), 9am to 5pm (Face-to-face or Online)
- 19 Dec 2024 (Thu), 1.30pm to 5pm (Online)

Venue: A3 (Level 1, near HangOutz room, beside 3Soar classroom)

Students and parents may make an appointment at:

<https://go.gov.sg/ecgcmsteoh>

Or scan the QR Code →

Please have this ready during the session

- Result Slip & Form N
- Prelim Result Slip if you are taking O Level Subject(s)
- ITE's Admission and Course Information brochure



<https://go.gov.sg/ecgcmsteoh>



Course Counselling at ITE

Students are encouraged to **call the helpline** to make an appointment **before** visiting the Customer & Visitor Centres at the respective ITE colleges.

ITE Headquarters & ITE College Central

Hotline: 1800 222 2111 / 6590 2211

ITE College East

Hotline: 6590 2262

ITE College West

Hotline: 6590 2628

Parents or students with course enquiries can call the respective college or go down to:

ITE Central Blk A Level 2

16 Dec **3pm – 5.30pm**

17 – 19 Dec **8.30am – 5.30pm**

ITE staff will be stationed there to help with the enquires.

- ❖ For general course advising, students may make an appointment online with ITE Education & Career Coaches via <https://for.edu.sg/ecg>



Education and Career Guidance (ECG) Support for 'N' Level Students

To complement the ECG services provided by schools, students can also consult an ECG Counsellor at the MOE ECG Centre. The MOE ECG Centre offers **online or phone counselling services** to GCE N-Level students from:

Date: 9 – 24 December 2024

Time: *9.00 am to 5.00 pm*

To make an online or phone counselling appointment, visit <https://go.gov.sg/moe-ecg-centre>



POLYTECHNIC FOUNDATION PROGRAMME (PFP)

Essential Things You Need to Know

1. What is the PFP?

- A foundation year at the polytechnics that:
 - Prepares well-performing Sec 4N(A) students for entry into relevant polytechnic diploma courses
 - Serves as an alternative to Sec 5
- Conducted over two academic semesters at the polytechnics
- Students must pass all PFP modules in order to progress to their respective, pre-selected diploma courses.

2. Am I eligible for PFP 2025?

- You are eligible for the PFP if you:
- Sat for GCE N-Level exams as a school candidate in 2024
 - Have obtained an ELMAB3 aggregate of 12 points or less (before deduction of CCA bonus points)
 - Met subject-specific entry requirements as listed on the PFP portal

If you can check all 3 boxes above, you're eligible!
 (Note: Eligibility does not guarantee you a place in a PFP course)

If you had offered GCE O-Level examination subjects in 2024, you may refer to this table for the equivalent grade to compute your ELMAB3 aggregate:

GCE 'O' Level Grade	Converted Grade
A1-B3	1
B4-C6	2
D7	3
E8	4

3. How do I apply?

- Upon release of the GCE O-Level results, all PFP-eligible students will receive Form P containing a PFP PIN that allows them to apply for the PFP at this [link](#).
- You may select up to five course choices.
- Remember to provide updated contact details in your application to allow the polytechnics to contact you if necessary.
 (Note: You should continue to attend Sec 5 from 2 January 2025 while applying for PFP.)

4. How will I be informed of the outcome?

- You should log in to the PFP portal to check your application outcomes on the day of PFP posting results release.
- You will then have to indicate if you wish to accept/reject/appeal the offer.
- If you do not select any option, your offer will become invalid and you will be required to continue with your classes in Sec 5/DPP.
 (Note: If your appeal is successful, your original offer will be voided, regardless of whether you accept the new PFP offer.)

5. What happens next?

- If you accept your offer, you will receive an enrolment package from the polytechnic in February/March 2025.
- The PFP year will start in April 2025.

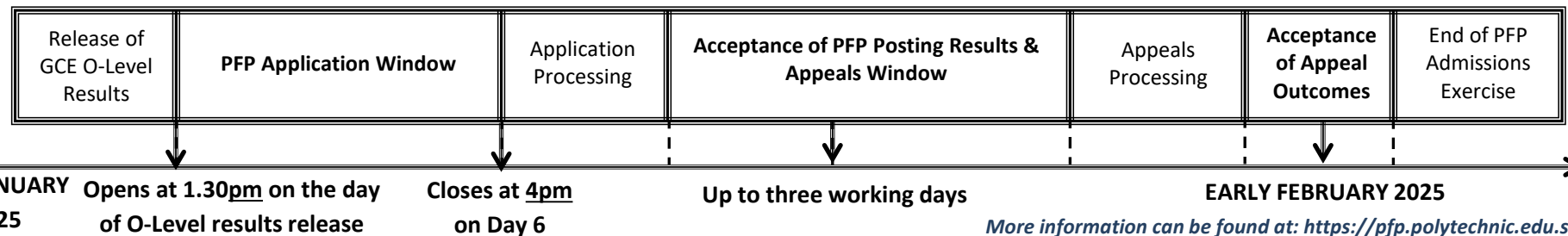

DIRECT-ENTRY-SCHEME TO POLYTECHNIC PROGRAMME (DPP)

5 Things You Need to Know

1. What is the DPP?

- Prepares Sec 4N(A) students for progression into selected polytechnic diploma courses via a 2-year *Higher Nitec* programme at ITE, and a 10-week DPP preparatory course
 - Serves as an alternative to Sec 5
- DPP students who meet the minimum qualifying GPA score are guaranteed a place in a polytechnic diploma course mapped to the *Higher Nitec* course. (Refer to <https://www.ite.edu.sg/admissions/full-time-courses/higher-nitec-dpp> for course mapping.)
- About 1,200 places offered across 18 *Higher Nitec* courses

2. Am I eligible for DPP?

- Sec 4N(A) student who has sat for GCE N-Level exams in 2024
- Obtained ELMAB3 aggregate of 19 points or less (before deduction of CCA bonus points)
- Meet course-specific entry requirements
- If you can check all 3 boxes above, you're eligible!** (Note: Eligibility *does not* guarantee placement.)

If you have offered GCE O-Level examination subjects in 2024, you may refer to this table for the equivalent grade to compute your ELMAB3 aggregate:

GCE O-Level Grade	Converted Grade
A1-B3	1
B4-C6	2
D7	3
E8	4

3. How do I apply?

- Upon release of the GCE N-Level results, all DPP-eligible students may apply for DPP *Higher Nitec* courses via the ITE website (<https://www.ite.edu.sg>).
- You may select up to 12 course choices.
- Remember to provide updated contact details in your application so that ITE can contact you if necessary.

4. How will I know the outcome?

- You should check your DPP posting results online on the morning of the release of the DPP posting results.
- You will then have to indicate if you wish to accept/reject/appeal the offer.
- Your offer will be void if you do not accept the offer by the stipulated date. You will be required to continue with your classes in Sec 5, or with your *Nitec / Higher Nitec* course if your application via JIE 'N' is successful

5. What happens next?

Upon accepting your DPP offer, you will attend a 10-week DPP preparatory programme starting from Jan 2025.

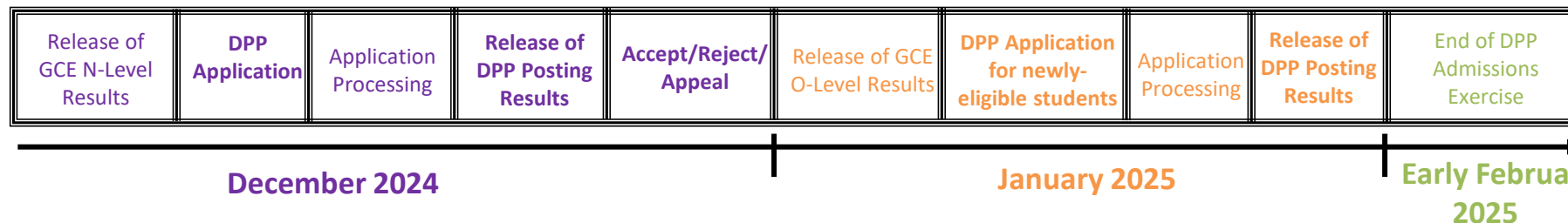

Testimony of Bryan Chia



- ▶ Went to ITE West (Engineering) after N levels with EMB3=16
- ▶ Graduated GPA 4.0 at ITE West
- ▶ Went to Singapore Polytechnic on SP Scholarship (Engineering with Business)
- ▶ Graduated GPA 4.0 at Singapore Polytechnic
- ▶ At NTU now on NTU Scholarship (Accounting with Business)

Collection of results

Things to note



What should be collected?

For All School Leavers Who Qualify For ITE

- a) 1 copy of Form N
- b) 1 copy of ITE's Admission and Course Information brochure



Appeal for review of results

Type of appeal	Fees (inclusive of 7% GST)
Individual Appeal	All citizenship: S\$114.45
Group Appeal	S\$713.95 (for the first five candidates) S\$103.55 (for each additional candidate up to a maximum of 15 candidates)

- Request and payment to be submitted by **Thursday, 19 December 2024, 4pm** through your form teacher.
- Payment can be made by cash or cheque.
- The outcome of the Individual Appeal is expected to be released to schools by Friday, 31 January 2025
- The outcome of the Group Appeal is expected to be released to schools by Mid-February 2025.



Certificate Amendment Request

- Request to re-print if the names were printed wrongly due to misspelling.
- Amendment fee of \$50 (inclusive of GST) for each certificate to be printed.
- Request to be submitted by **Thursday, 19 December 2024, 4pm**
- Approach form teacher for submission of request



Summary of important dates

1. Amendment of name in exam certificate: Thursday, 19 December 4pm
2. Appeal of results: Thursday, 19 December 4pm
3. JIE application window (1st phase): 16 Dec 2.30pm to 19 Dec 5pm
4. DPP application window: 16 Dec 2.30pm to 19 Dec 5pm
5. PFP application will commence upon release of O level results in Jan 2025



Think Opportunities

As you await your GCE N-Level results, there are some possibilities:

- You are happy that your results meet your expectations,
- You are overjoyed that your results exceed your expectations, or
- You are worried/upset because your results fall short of your expectations.

Many pathways and opportunities!

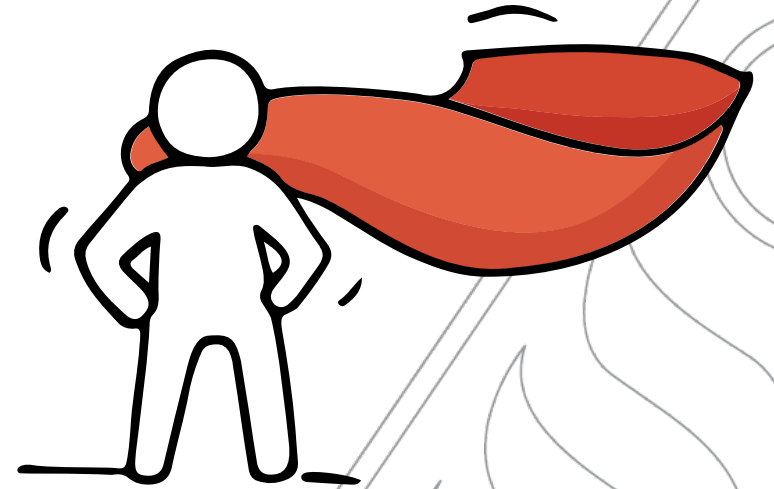

Reaching out for help is a sign of strength, not weakness.

If you have any questions about your options or are not coping well, do reach out to someone you trust and speak with them. It could be a parent/guardian, teacher, ECG Counsellor, School Counsellor or a friend that you can talk to.

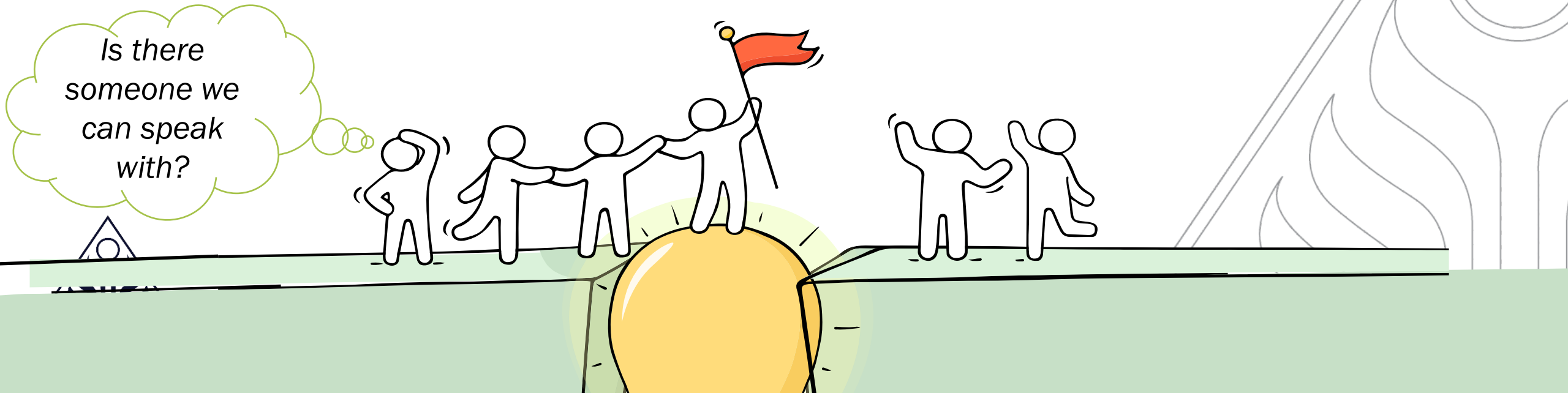

Support is readily available for you.

Reach out to an ECG Counsellor!

Who can we go to for ECG advice?

Make an appointment to speak with your ECG Counsellor in school.

OR

Make an ECG counselling appointment via the ECG Centre @ MOE (Grange Road) at

<https://go.gov.sg/moe-ecg-centre>

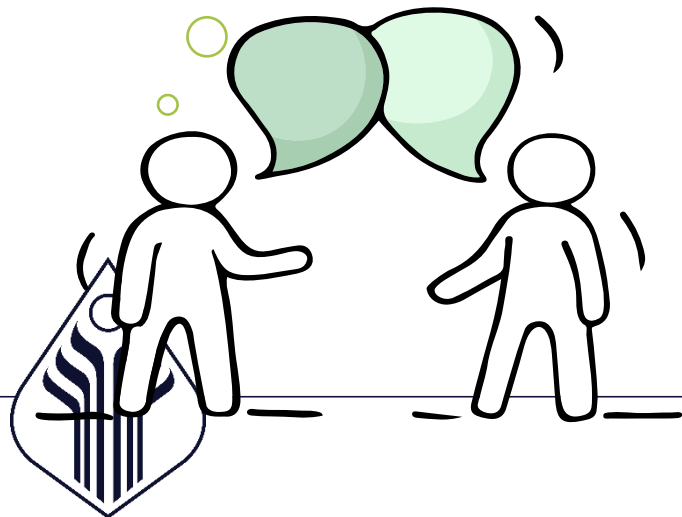

Support is readily available for you.

There are other hotlines and chats available if you are more comfortable seeking help using these platforms. Scan the QR code below for a helpful resource.



SOS provides round-the-clock emotional support for those in distress, thinking of suicide or affected by suicide.

Call: **1767**
(24-hour helpline)

Whatsapp: **9151 1767**
(24-hour Care Text)

TOUCHline is a helpline to provide youths with emotional support and practical advice.

Call: **1800-377 2252**
*Monday- Friday (Excluding Public Holidays):
9am – 6pm*

Community Health Assessment Team (CHAT) provides personalised and confidential mental health checks and consultation for youths. To speak with a youth support worker, you can:

Visit: **CHAT Hub at *SCAPE, #05-05**
Call: **6493 6500/ 6501**
Email: **CHAT@mentalhealth.sg**

Carey is an online platform by Care Corner that provides free mental health check-ins with mental health professionals. Find out more at:
<https://carey.carecorner.org.sg/>

mindline.sg is an online platform that provides tools, tips and resources to help you manage your health and well-being. Find out more at:
www.mindline.sg



eC2 is an e-Counselling Centre where you can talk to a trained counsellor about the issues you are facing, right where you are.

Chat with a counsellor at:
www.ec2.sg
*Monday – Friday (Excluding Public Holidays):
10am – 12pm & 2pm – 5pm*



**The N-Level
examination is not
the destination.**

**It is part of your
education journey.**



- Any further queries or clarifications, you may look out for:

Mr Chew Kang Wei (SH/A-Math)

Mrs Adeline Tan (LH/LSS)

Mr Selvam (Asst YH/Sec 4&5)

Mr Hilmi (School Counsellor)

For ECG consultation:

Mr Koh Yong Cheng (YH/Upper Sec)

Ms Teoh Fan Yun (Senior ECG counsellor)

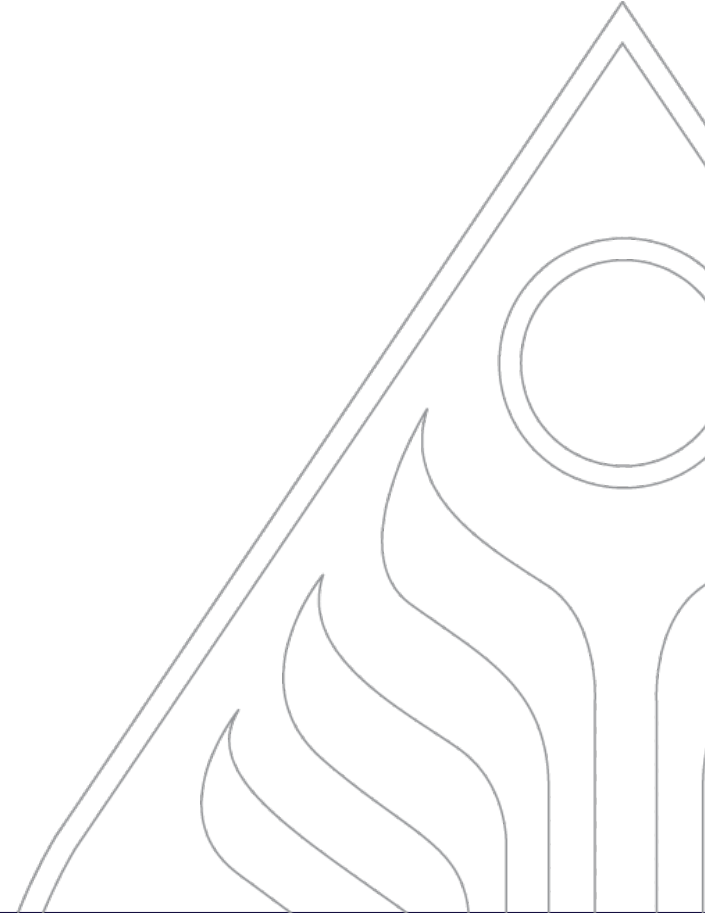

Thank you

